

WITH MYLAR SKETCH

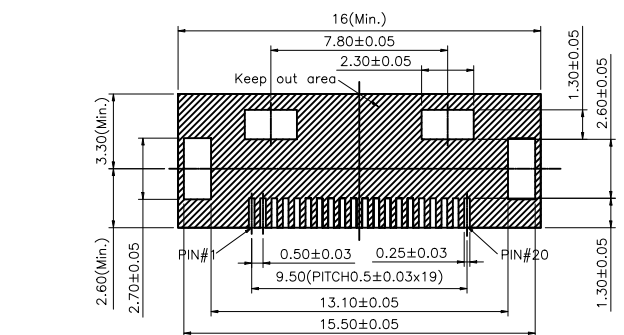

RECOMMENDED PCB LAYOUT

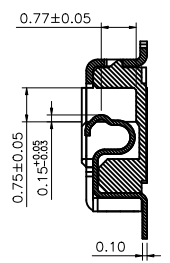
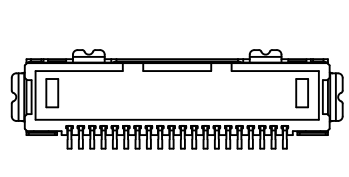

SECTION A-A
(SCALE 2:1)

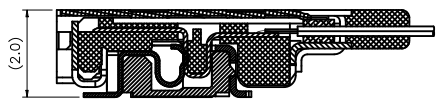

Mating condition(Cable assembly)

REV.	ECN NO.	DESCRIPTION	DATE	DESIGN
A		调整电气性能描述&更新图框	2021.11.12	XUETAOGUO

NOTE:
 1.MATERIAL:SEE BOM
 2.FINISH: CONTACT: 50U"MIN,NICKEL UNDERPLATING OVERALL. SURFACE FOLLOW THE P/N.
 3. SPEC. PLS. REFER TO EI100:
 4.ORDERING INFORMATION:

LV0523H -XX X X X X - X

WITHOUT "H" : WITH HALOGEN
 WITH "H" : HALOGEN FREE

PIN NO.:
 20:20P

□: WITHOUT LOGO
 V: WITH LOGO
 □: WITHOUT MYLAR
 M: WITH MYLAR

PACKING:
 0:REEL
 3:TARY

G:GOLD FLASH
 T : AU 3U" ON CONTACT AREA
 T5: AU 5U" ON CONTACT AREA
 T8: AU 8U" ON CONTACT AREA
 T10:AU 10U" ON CONTACT AREA
 T15:AU 15U" ON CONTACT AREA

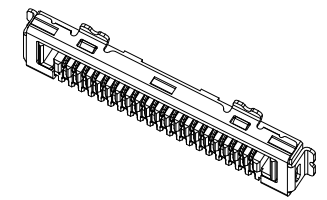

4	SHELL	1	C5210
3	TERMINAL	20	C7035
2	MYLAR	1	POLYIMIDE FILM TAPE
1	HOUSING	1	THERMALPLASTIC LCP E471i,UL94-V0
NO.	DESCRIPTION	Q'TY.	MATERIAL

一般公差 TOLERANCES X ±0.5 .XX ±0.2 X ±0.3 .XXX ±0.1 ANGLES ±2°		希尔盛精密电子(昆山)有限公司	
檢驗尺寸標示 SYMBOLS INDICATE CLASSIFICATION DIMENSION	品名 (TITLE) 0.5MM PITCH FINE COAXIAL BOARD RECEPTACLE 20 POS 通用型	製圖 (DR) XUETAOGUO	
MARK IS CRITICAL DIM. MARK IS MAJOR DIM.	圖號 (DWG NO.) C-LV0523H-20XXX-X	審核 (CHKD) LEO-HE	
表面處理 (FINISH)	比例 (SCALE) 5:1	單位 (UNITS) mm	張數 (SHEET) 1 OF 1
		核准 (APPD) LEO-HE	SIZE A4
			REV A

REV.	ECN NO.	DESCRIPTION	DATE	DESIGN
A		调整电气性能描述&更新图框	2021.11.12	XUETAOGUO

NOTE:
 1.MATERIAL:SEE BOM
 2.FINISH: CONTACT: 50U"MIN,NICKEL UNDERPLATING OVERALL.
 SURFACE FOLLOW THE P/N.
 3. SPEC. PLS. REFER TO EI100:
 4.ORDERING INFORMATION:

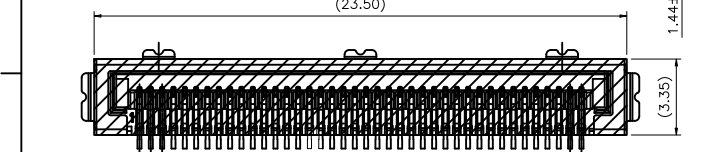
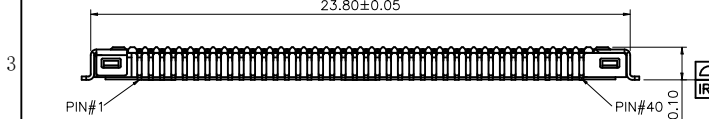
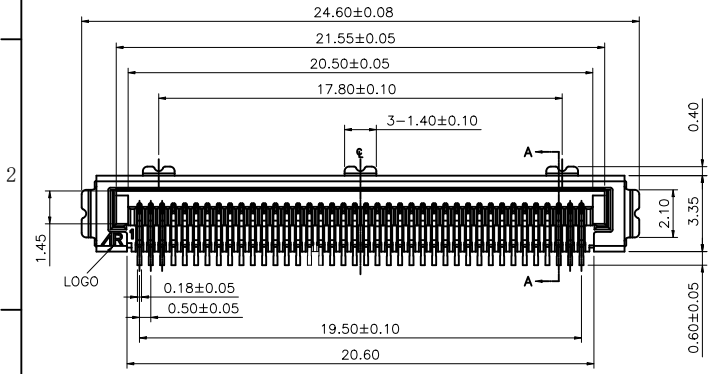
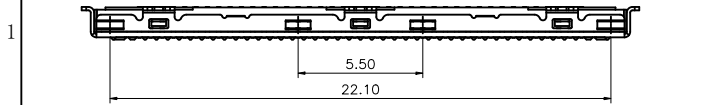

WITH MYLAR SKETCH

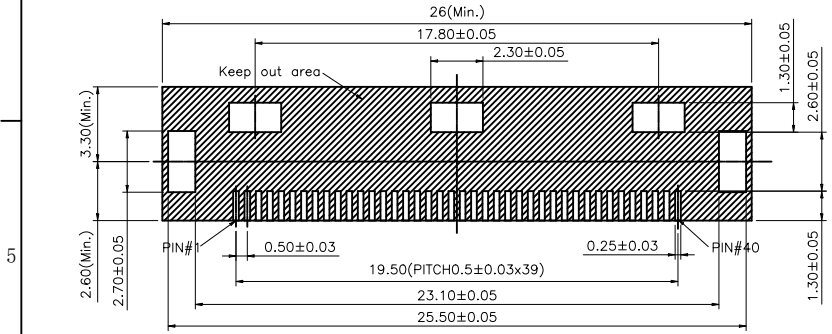

RECOMMENDED PCB LAYOUT

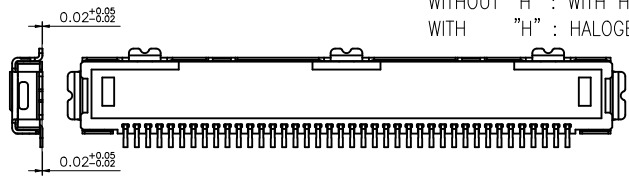

WITHOUT "H" : WITH HALOGEN
 WITH "H" : HALOGEN FREE

LV0523H -XX X X X X - X

□: WITHOUT LOGO
 V: WITH LOGO
 □: WITHOUT MYLAR
 M: WITH MYLAR

B:BLACK
 N:NATURAL
 PLATING SPEC

PACKING: G:GOLD FLASH
 0:REEL T : AU 3U" ON CONTACT AREA
 3:TARY T5: AU 5U" ON CONTACT AREA
 T8: AU 8U" ON CONTACT AREA
 T10:AU 10U" ON CONTACT AREA
 T15:AU 15U" ON CONTACT AREA

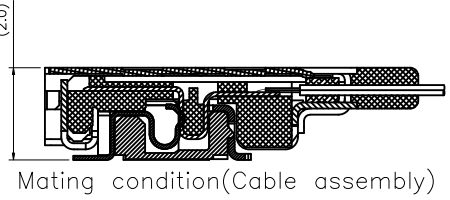

Mating condition(Cable assembly)

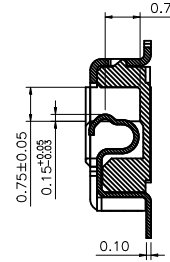

SECTION A-A
 (SCALE 2:1)

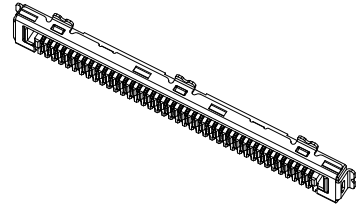

4	SHELL	1	C5210
3	TERMINAL	40	C7035
2	MYLAR	1	POLYIMIDE FILM TAPE
1	HOUSING	1	THERMALPLASTIC LCP E471i,UL94-V0
NO.	DESCRIPTION	Q'TY.	MATERIAL

一般公差 TOLERANCES X ±0.5 .XX ±0.2 X ±0.3 .XXX ±0.1 ANGLES ±2°		希尔盛精密电子(昆山)有限公司	
檢驗尺寸標示 SYMBOLS INDICATE CLASSIFICATION DIMENSION MARK IS CRITICAL DIM. MARK IS MAJOR DIM.	品名 (TITLE) 0.5MM PITCH FINE COAXIAL BOARD RECEPTACLE 40 POS 通用型	製圖 (DR) XUETAOGUO	5
	圖號 (DWG NO.) C-LV0523H-40XXX-X	審核 (CHKD) LEO-HE	
表面處理 (FINISH)	比例 (SCALE) 5:1	單位 (UNITS) mm	張數 (SHEET) 1 OF 1
		核准 (APPD) LEO-HE	SIZE A4
			REV A